

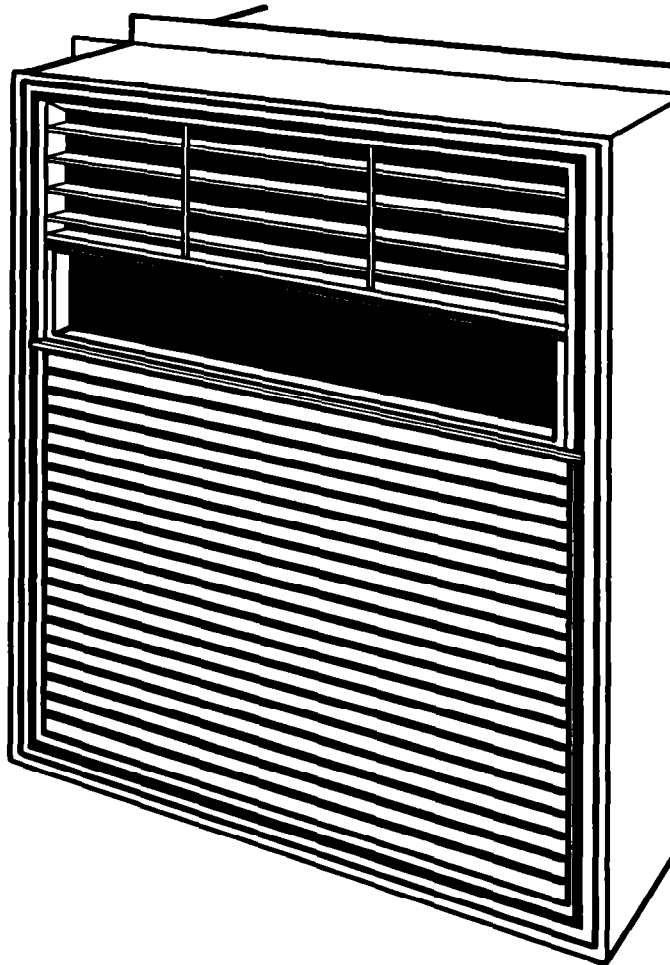

Installation, Use And Care

G U I D E



A Note To You	2
Important Safety Instructions	3
Parts And Features	4
Installing Your Air Conditioner	5
Operating Your Air Conditioner	17
Caring For Your Air Conditioner	20
If You Need Assistance Or Service	24
Warranty	28

1-800-253-1301
Call with questions or comments.

SLIDER/CASEMENT WINDOW AIR CONDITIONERS

MODELS ACS102 ACS520

3/94

A Note To You

Thank you for buying a Whirlpool® appliance.

You have purchased a quality, *world-class* home appliance. Years of engineering experience have gone into its manufacturing. To ensure that you will enjoy many years of trouble-free operation, we have developed this Use and Care Guide. It is full of valuable information on how to operate and maintain your appliance properly and safely. Please read it carefully. Also, please complete and mail the Ownership Registration Card provided with your appliance. This will help us notify you about any new information on your appliance.

Your safety is important to us.

This guide contains safety symbols and statements. Please pay special attention to these symbols and follow any instructions given. Here is a brief explanation of the use of each symbol.

⚠ WARNING

This symbol will help alert you to such dangers as personal injury, burns, fire and electrical shock.

⚠ CAUTION

This symbol will help you avoid actions which could cause product damage (scratches, dents, etc.) and damage to your personal property.

Our Consumer Assistance Center number, 1-800-253-1301, is toll-free, 24 hours a day.

If you ever have a question concerning your appliance's operation, or if you need service, first see "If You Need Assistance Or Service" on page 24. If you need further help, feel free to call our Consumer Assistance Center. When calling, you will need to know your appliance's complete model number and serial number. You can find this information on the model and serial number plate (see diagram on page 4). For your convenience, we have included a handy place below for you to record these numbers, the purchase date from the sales slip and your dealer's name and telephone number. Keep this book and the sales slip together in a safe place for future reference.

Model Number _____

Dealer Name _____

Serial Number _____

Dealer Phone _____

Purchase Date _____

IMPORTANT SAFETY INSTRUCTIONS

Important Safety Instructions

⚠ WARNING

To reduce the risk of fire, electrical shock or personal injury when using your air conditioner, follow these basic precautions:

- Read all instructions before using your air conditioner.
- Complete the installation requirements as described in the Installation Instructions.
- Do not allow children to operate or play with the air conditioner.
- Do not operate the air conditioner with the front panel removed.
- Never clean air conditioner parts with flammable fluids. The fumes can create a fire hazard or explosion.

• FOR YOUR SAFETY •

DO NOT STORE OR USE GASOLINE OR OTHER FLAMMABLE VAPORS OR LIQUIDS IN THE VICINITY OF THIS OR ANY OTHER APPLIANCE. THE FUMES CAN CREATE A FIRE HAZARD OR EXPLOSION.

– SAVE THESE INSTRUCTIONS –

Help us help you

Please:

- Install the air conditioner in a window that will hold the weight and secure it in accordance with the Installation Instructions.
- Connect the air conditioner only to the proper kind of outlet with the correct electrical supply and grounding. (See the Installation Instructions.)
- Be sure the air conditioner is the correct size for the area you want to cool.
- Use the air conditioner only for its intended purpose.
- Be sure the air conditioner is not used by anyone unable to operate it properly.
- Maintain the air conditioner properly.

Also, remove the Energy Label and Buy Guide. Use a damp cloth to take off any glue residue. Do not use sharp instruments, flammable fluids or abrasive cleaners. These can damage the material.

PARTS AND FEATURES

Parts And Features

This section contains captioned illustrations of your appliance. Use them to become familiar with where all parts and features are located and what they look like.

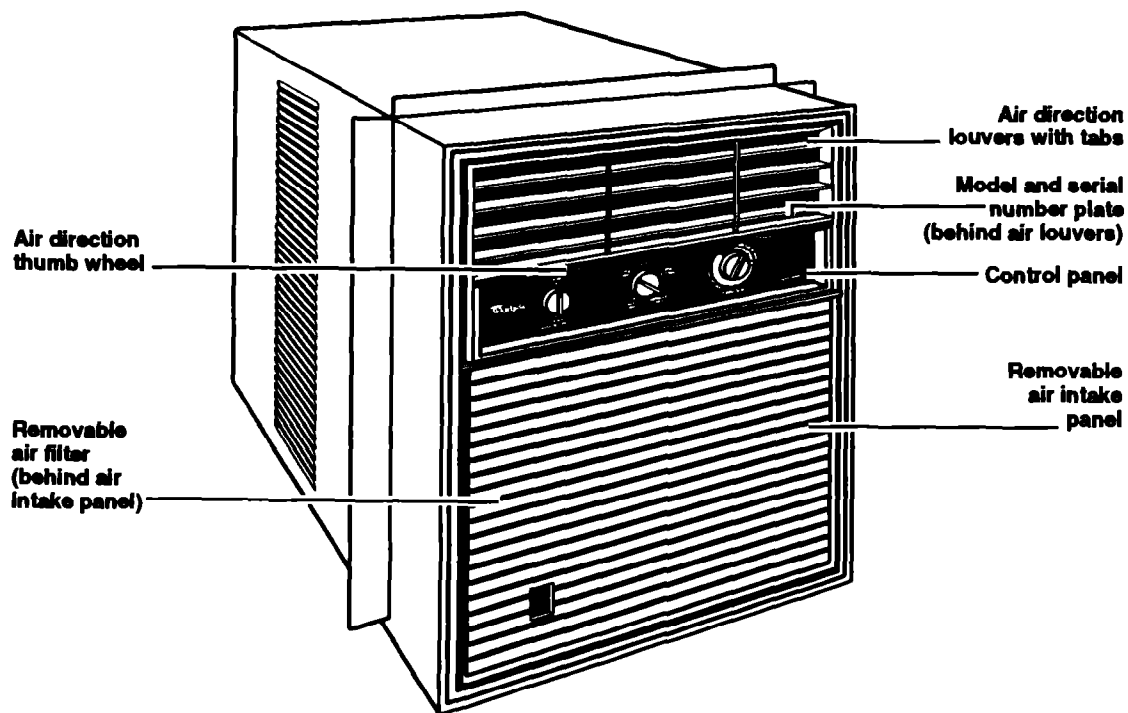

Control Panel

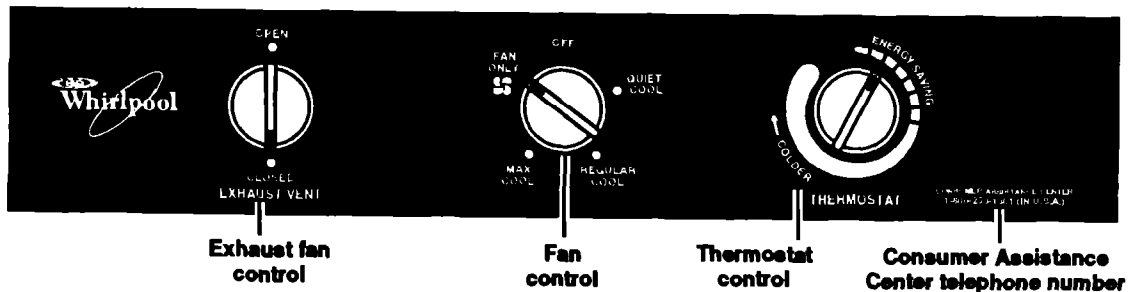

Installing Your Air Conditioner

In This Section	
	Page
Meeting electrical requirements	5
Preparing for installation	6
Installing in a sliding window	8
Installing in a casement window	13

Proper installation of your air conditioner is important for proper operation and best cooling results. This section will tell you how to meet necessary electrical requirements and how to install your air conditioner properly into a sliding or casement style window. Please read these installation instructions, as well as the operating and care instructions, before installing your unit.

Meeting electrical requirements

⚠ WARNING

Electrical Shock and Personal Injury Hazard

- Electrical ground is required on this appliance.
- **DO NOT** modify the power supply cord plug. If it does not fit the outlet, have a proper outlet installed by a qualified electrician.
- **DO NOT** have a fuse in the neutral or grounding circuit. A fuse in the neutral or grounding circuit could result in an electrical shock.
- **DO NOT** use an extension cord with this appliance.
- Check with a qualified electrician if you are in doubt as to whether the appliance is properly grounded.

Failure to follow these instructions could result in electrical shock, serious injury or death.

OBSERVE ALL LOCAL CODES AND ORDINANCES.

DO NOT, UNDER ANY CIRCUMSTANCES, REMOVE THE POWER SUPPLY CORD GROUNDING PRONG.

NOTE: If codes permit and a separate grounding wire is used, it is recommended that a qualified electrician determine that the grounding path is adequate and not interrupted by plastic, non-metallic gaskets or other insulating materials.

Receptacle wiring

Receptacle wiring should be a minimum of 14-gauge. Use copper wire only. It is the responsibility of the consumer to provide proper and adequate receptacle wiring, installed by a qualified electrician. Observe the National Electrical Code and all local governing codes and ordinances.

Electrical requirements

A 115 volt (103.5 minimum, 126.5 maximum), 60 Hertz, AC only, 15 ampere fused electrical supply is required. A time delay fuse or time delay circuit breaker is also required. A separate circuit, serving only this appliance, **must** be provided.

INSTALLING YOUR AIR CONDITIONER

Electrical connection

Electrical ground is required on this appliance.

Recommended grounding method

For your personal safety, this appliance must be grounded. This air conditioner is equipped with a power supply cord with a 3-prong grounding plug. To minimize possible electrical shock hazard, the cord must be plugged into a mating 3-prong grounding-type wall receptacle, grounded in accordance with the National Electrical Code (ANSI/NFPA 70-latest version) and all local codes and ordinances. If a mating 3-prong grounding-type wall receptacle is not available, it is the responsibility of the consumer to have a properly grounded 3-prong wall receptacle installed by a qualified electrician.

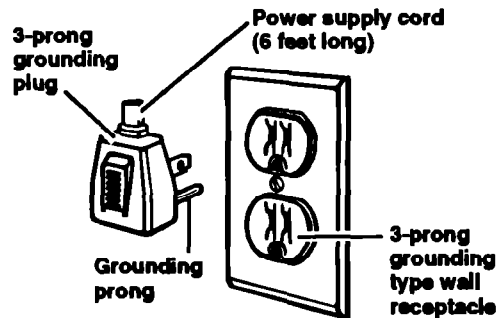

Preparing for installation

Installation tips

For wood-frame casement windows: It may be necessary to construct a frame, using at least 1-inch thick wood, with a 15½-inch wide opening. Fasten frame securely and seal it into the window opening.

For brick or cement building construction: It may be necessary to provide a wood stool strip under the air conditioner for mounting purposes.

Tools required

- Flat-head screwdriver
- Phillips-head screwdriver
- Carpenter's level
- Tape measure
- Fine tooth saw
- Electric or hand drill
- ¼-inch drill bit
- ⅝-inch drill bit

⚠ WARNING

Personal Injury and Product Damage Hazard

- Because this air conditioner weighs about 88 to 105 pounds, it is recommended that you have someone help you when you install your new unit and that you both use proper lifting techniques.
 - This appliance must be installed according to all applicable codes and ordinances.
 - Handle the air conditioner with care. Watch out for the sharp metal fins on the front and rear coils.
 - Be sure your air conditioner does not fall during installation.
 - Do not use the water collected in the unit for drinking purposes. It is not sanitary.
- Failure to follow the above precautions could result in personal injury or product damage.

INSTALLING YOUR AIR CONDITIONER

1. Unpack the installation kit. Make sure you have all the necessary parts.

Installation kit contents:

- A.** Platform (1)
- B.** Adjustment bolt (1)
- C.** Screw – #10 x 2½" flat-head (2)
OR
Screw – #10 x 1¾" pan-head (2)
OR
Screw – #10 x 1" pan-head (2)
- D.** Safety bracket (1)
- E.** Screw – #8-32 x ¾" self-threading (7)
- F.** Track seal (1)
- G.** Foam seal strip/Sash seal (1)
- H.** Side channel seal (1)
- I.** Plastic window panel (1)
- J.** Window locking bracket (1)
- K.** Hex flange nut – ¼" (1)
- L.** Screw – #8 x ¾" round wood-head (6)
- M.** Support brace (1)

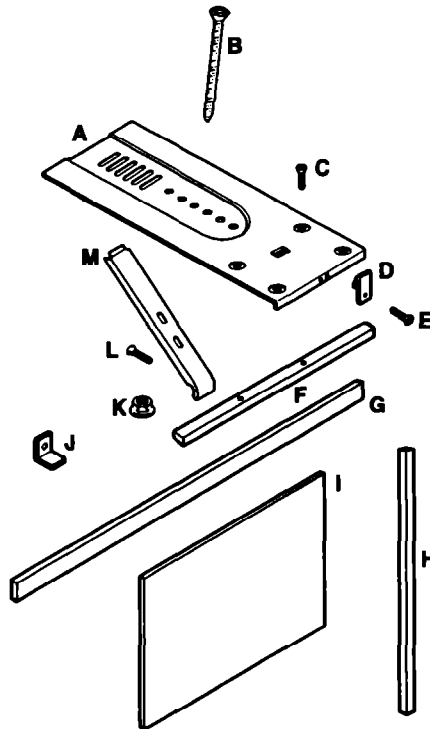

NOTE: Use the scale at the right to measure the length of your screws. This will come in handy when separating screws for installation.

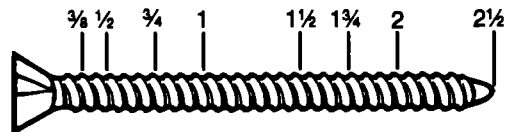

INSTALLING YOUR AIR CONDITIONER

2. Choose a proper size window.

- 15½ inches minimum width
- 16¼ inches maximum width (for casement windows)
- 21⅞ inches minimum height (with window panel retainer)
- 20⅞ inches minimum height (window panel retainer removed)
- 40 inches maximum height

NOTE: The height measurement must be of an unobstructed opening above the mounting platform. In some cases, due to a variety of stop and track arrangements, the above dimensions may vary slightly. If necessary, the installation can be made by altering the window jams. (See "Alternate window jamb applications" on page 12.)

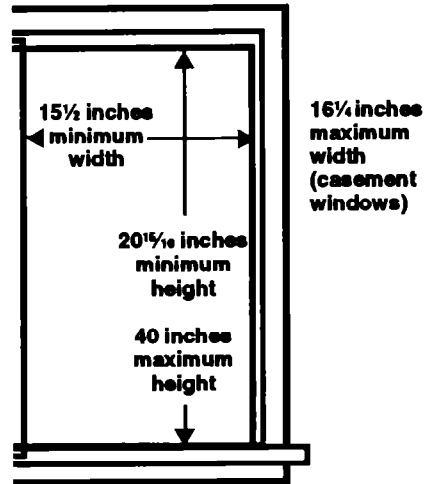

3. Choose the proper window location.

Choose a window that will allow the cooled air to flow freely and directly into the room(s) you want to cool. Remember, it is difficult to move air around corners. Also, choose a window that is within 6 feet of an electrical outlet. (See "Meeting electrical requirements" on pages 5-6 for receptacle and wiring needs.) Do not use an extension cord.

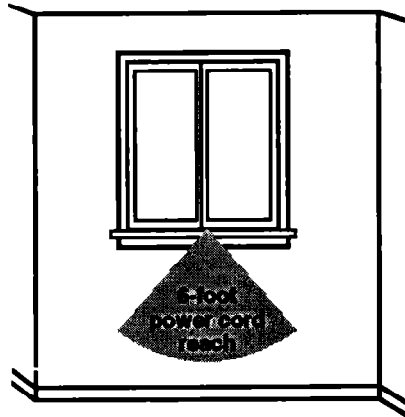

Installing in a sliding window

1. Attach support brace to platform as shown. Use the adjustment bolt and hex flange nut to complete the assembly. Choose the slot and adjustment bolt hole locations that will create a 45° angle between the platform and the support brace. Try the assembly in the window to determine if the platform will rest properly and allow the proper slope (⅜-inch lower on outside). Without the proper slope, water could drip into your home and cause water damage.

NOTE: If you are planning to use a siding-protection board (see Step 5) on the outside of your house, hold the board in place when testing the assembly in the window.

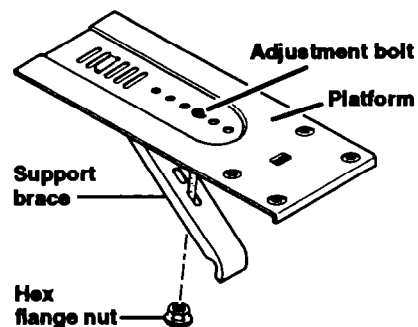

INSTALLING YOUR AIR CONDITIONER

2. **Measure and lightly mark a line** $8\frac{1}{16}$ -inches from the right window jamb.

NOTE: If any sash stop protrudes more than 1 inch from the side window jambs, the $8\frac{1}{16}$ -inch measurement must be increased accordingly. Screen and storm window frames may also require adjustments to the measurement.

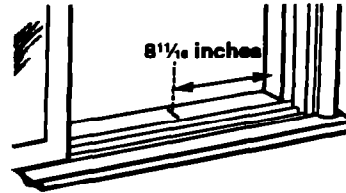

3. **Center the platform assembly** on the line with the inside platform tab pressed against the inside edge of the window track. Using the holes in the platform as a guide, mark and drill two $\frac{3}{16}$ -inch diameter holes. Drill holes in either track or stool.

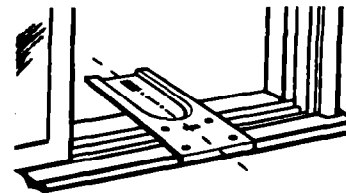

Center platform assembly on the line with platform tab pressed against window track.

Alternate screw location (depending on stool depth) Platform tab

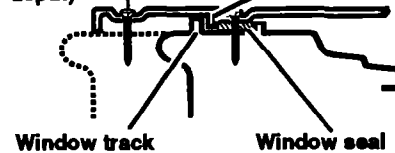

CAUTION

Property Damage Hazard

Be sure the wood stool or window track is securely attached to the building construction. Use longer screws into the sub-framing if necessary.

Failure to follow the above precaution could result in damage to the window or air conditioner.

4. **Peel off the protective backing** from the track seal. Apply seal to the room side of the window track. The center of the seal strip should coincide with the line marked in Step 2. The two screw holes drilled in Step 3 should be directly above the seal strip in the inner track.



Apply track seal to window side of track.

5. **Securely attach a siding-protection board** to the side of the house.

OR

To avoid permanent siding damage, attach the siding-protection board to the base of the support brace as shown.

NOTE: The siding-protection board should be long enough to span 2 wall studs.

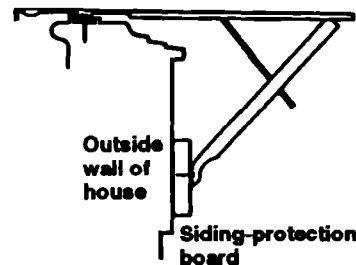

INSTALLING YOUR AIR CONDITIONER

6. Place platform assembly, with platform tab against inside of window track, and attach it to the window jamb. Use appropriate length screws (item C on page 7).
7. Adjust the platform assembly so that the outside edge is $\frac{3}{16}$ -inch lower than the inside edge. This ensures proper water drainage from the air conditioner.
8. Level the platform assembly from side-to-side. Also, make sure the window track is level. Use leveling shims as necessary to ensure the air conditioner will be level from side-to-side.

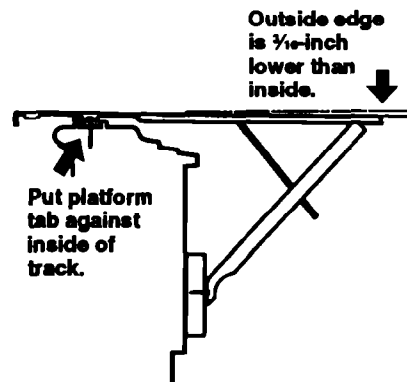

9. Measure the height of the window opening from the top of the platform assembly. Subtract $20\frac{1}{16}$ inches (the height of the air conditioner cabinet). Mark this measurement on the plastic window panel—along the longer side.
10. Clamp the plastic window panel between a board and a work table and cut along the cutting line with a fine tooth saw. Remove any burrs with a file.

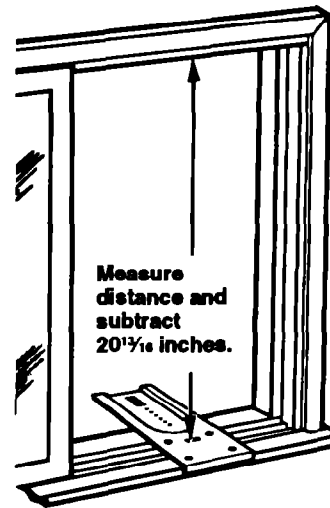

11. Lift the panel frame from the side channels of the air conditioner cabinet. Slide the plastic window panel into the frame with the smooth side to the outside. Slide the panel frame assembly back into the side channels of the air conditioner cabinet. Make sure the plastic window panel is firmly enclosed on all sides by the retainer grooves.

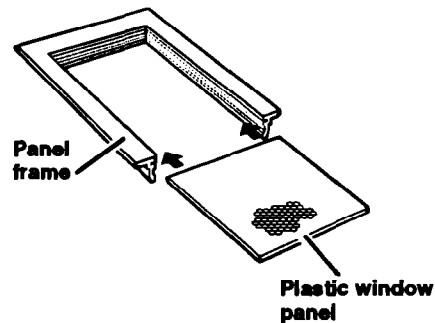

INSTALLING YOUR AIR CONDITIONER

12. **Cut side channel seal** into 2 equal lengths. Remove the protective backing and apply it to the rear side of the cabinet side channels, starting just below the panel frame assembly. Pinch off excess length so the seal is even with the bottom of the cabinet side channel.

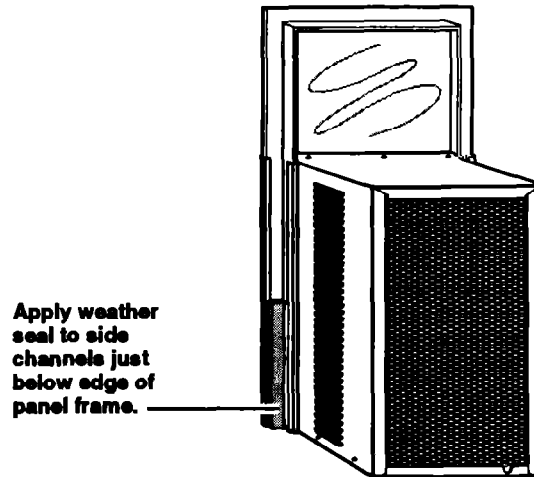

13. **Remove the air intake panel and front panel frame.** First, press down on the top edge of the air intake panel and tilt it toward you. Lift it up to release the bottom spring clips. Next, remove the 2 phillips-head screws holding the front panel frame in place. Finally, press down on the top edge of the front panel frame, tilt it forward, and lift it up off the bottom spring clips.
- NOTE:** Do not push or pull on the air direction louvers.

3. **Press down and tilt forward to remove front panel frame.**

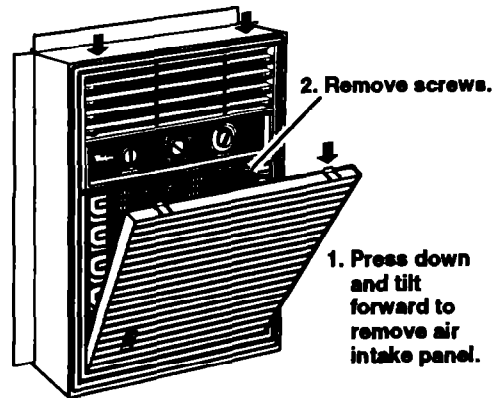

14. **Place the air conditioner in the window opening.** It should sit on the platform assembly so that the window panel frame and the cabinet side channels are against the top and side window jambs.

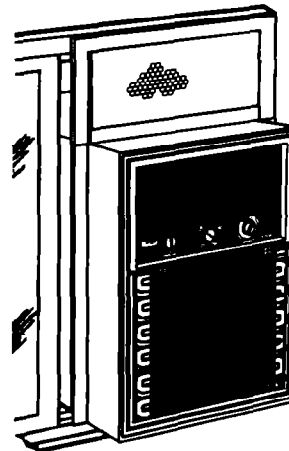

INSTALLING YOUR AIR CONDITIONER

15. **Slide the inner window sash firmly** against the side of the cabinet. Make sure not to peel the seal strips from the window track and cabinet side channels. If the panel frame does not fit snugly to the inner window sash, secure the panel frame to the sash with #8 x 3/4-inch wood screws or #8-32 x 3/4-inch self-threading screws. Use the partially plugged holes in the panel frame. For metal or plastic window sashes or jambs, drill 1/8-inch pilot holes for the self-threading screws.

NOTE: When installing screws in the window sash, be sure not to interfere with the glass inside the sash retaining channel.

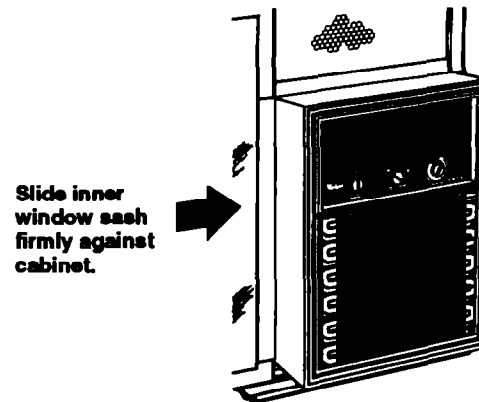

16. **Hook the safety bracket** over the base of the unit and fasten it to the front of the platform assembly. Use a #8-32 x 3/4-inch self-threading screw.

NOTE: The bracket prevents movement of the air conditioner (either in or out) after completing the installation.

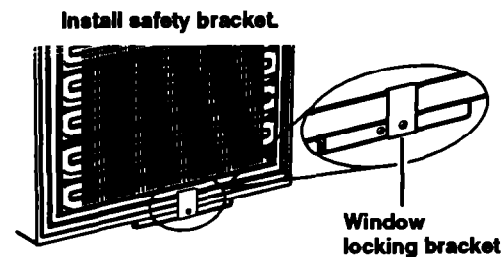

17. **Stuff the foam seal strip/sash seal** between the vertical sash and the window glass.
18. **Use the window locking bracket** to lock the inner window sash to the base of the outer window sash. Use one #8 x 3/4-inch wood screw or #8-32 x 3/4-inch self-threading screw. (See illustration.)
19. **Replace the air conditioner front panel frame and air intake panel.** Make sure you replace the 2 screws that hold the front panel frame in place before you replace the air intake panel.

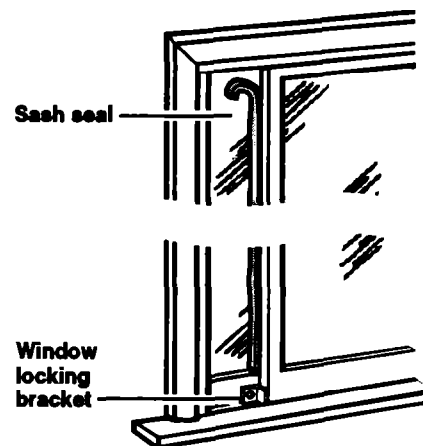

Alternate window jamb applications

To install in windows having no flanges or wood stops on the top and side jambs, the channels and panel frame must fit against a mating flange (or 1/8-inch max. thick angle) attached to the window jambs. Figure A shows this angle installed. Figures B & C show alternate treatments. On the sash side of the opening, the leading corner of the inner sash becomes the flange. You can purchase the angle strip locally.

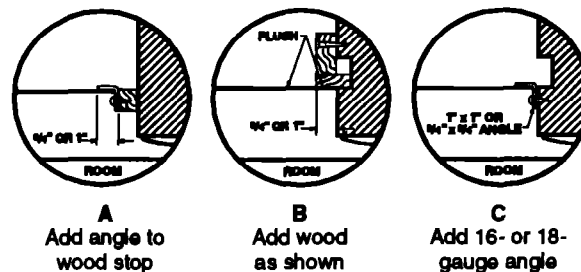

Installing in a casement window

NOTE: Open the window the maximum amount to allow for clearance of the cabinet. The crank handle should be removed to allow the platform to be fastened to the jamb. If the window cannot open far enough (more than 15½ inches) for the cabinet to clear the window, remove the window entirely by drilling out the rivets. Bolts can serve as the pivots in the future.

To avoid the crank handle and window clearance problems, the unit can be installed in a stationary sash section. However, the horizontal mullion and the 2 glass panels must be removed before installation.

- 1. Attach support brace to platform as shown.** Use the adjustment bolt and hex flange nut to complete the assembly. Choose the slot and adjustment bolt hole locations that will create a 45° angle between the platform and the support brace. Try the assembly in the window to determine if the platform will rest properly and allow the proper slope (¼-inch lower on outside).

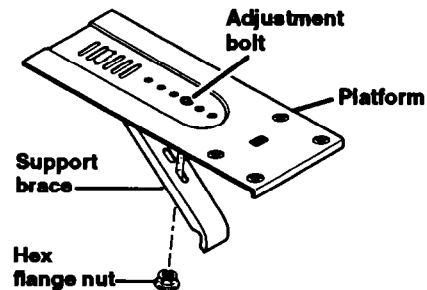

NOTE: If you are planning to use a siding-protection board (see step 5) on the outside of your house, hold the board in place when testing the assembly in the window.

- 2. Drill a ¼-inch diameter pilot hole in the window jamb** an equal distance from each side of the jamb and ¾-inch up from the window sill. If the hole coincides with the window lever slot in the jamb bottom, an additional hole will have to be drilled through the platform edge and the window jamb to miss this slot.

Equal distance from both sides

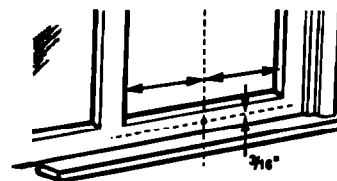

- 3. Peel off the protective backing from the track seal and stick the seal to the window sill on the outside of the bottom jamb.**

Apply track seal to the outside edge of the bottom window jamb.

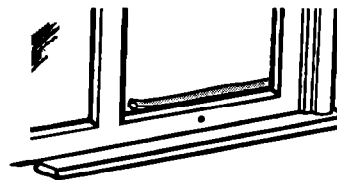

- 4. Screw the platform assembly to the window jamb through the pilot hole you drilled in Step 2.** Use a #8 x ¾-inch self-threading screw.

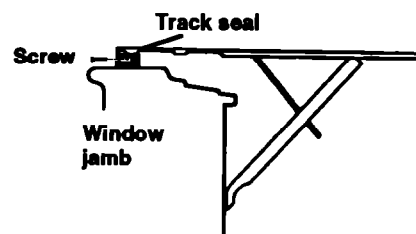

INSTALLING YOUR AIR CONDITIONER

5. Adjust the platform assembly so that the rear of the air conditioner will be $\frac{3}{8}$ -inch lower than the front. This ensures proper water drainage from the air conditioner.

NOTE: A projection below the base of the air conditioner will require the rear of the platform to be $\frac{7}{8}$ -inch lower than the front to create the $\frac{3}{8}$ -inch slat from front to rear.

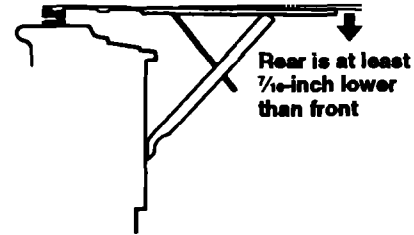

6. Securely attach a siding-protection board to the side of the house where the platform assembly hits the house. The siding-protection board should be long enough to span 2 wall studs.

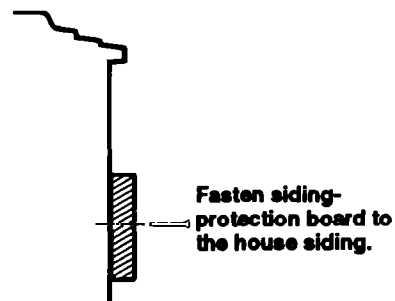

7. Measure the height of the window opening from the top of the platform assembly. Subtract $20\frac{1}{8}$ inches (the height of the air conditioner cabinet). Mark this measurement on the plastic window panel—along the longer side.
8. Clamp the plastic window panel between a board and a work table and cut along the cutting line with a fine tooth saw. Remove any burrs with a file.

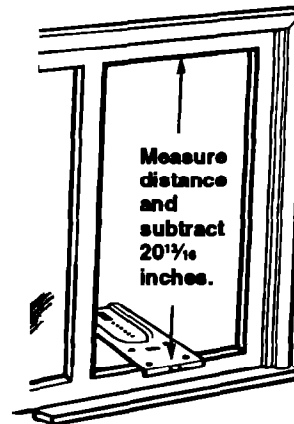

9. Lift the panel frame from the side channels of the air conditioner cabinet. Slide the plastic window panel into the frame with the smooth side to the outside. Slide the panel frame assembly back into the side channels of the air conditioner cabinet. Make sure the plastic window panel is firmly enclosed on all sides by the retainer grooves.

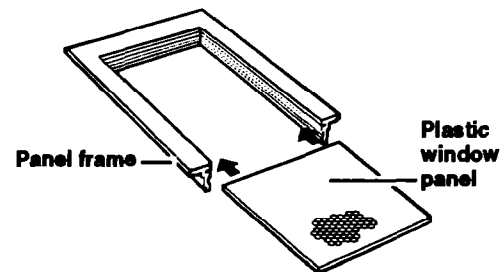

INSTALLING YOUR AIR CONDITIONER

10. **Cut side channel seal** into 2 equal lengths. Remove the protective backing and apply it to the rear side of the cabinet side channels, starting just below the panel frame assembly. Pinch off excess length so the seal is even with the bottom of the cabinet side channel.

Apply weather seal to side channels just below edge of panel frame.

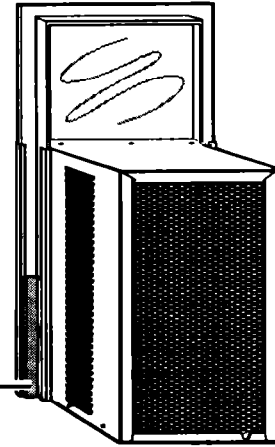

11. **Remove the air intake panel and front panel frame.** First, press down on the top edge of the air intake panel and tilt it toward you. Lift it up to release the bottom spring clips. Next, remove the 2 phillips-head screws holding the front panel frame in place. Finally, press down on the top edge of the front panel frame, tilt it forward, and lift it up off the bottom spring clips.

NOTE: Do not push or pull on the air direction louvers.

3. Press down and tilt forward to remove front panel frame.

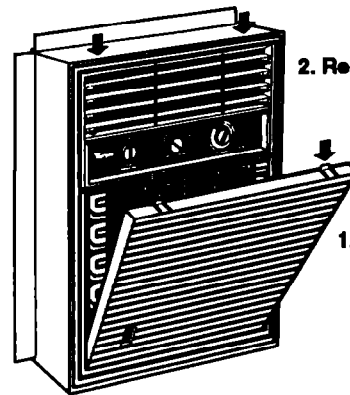

2. Remove screws.

1. Press down and tilt forward to remove air intake panel.

12. **Place the air conditioner in the window opening.** It should sit on the platform assembly so that the window panel frame and the cabinet side channels are against the top and side window jambs. Side channels should overlap side window jambs equally.

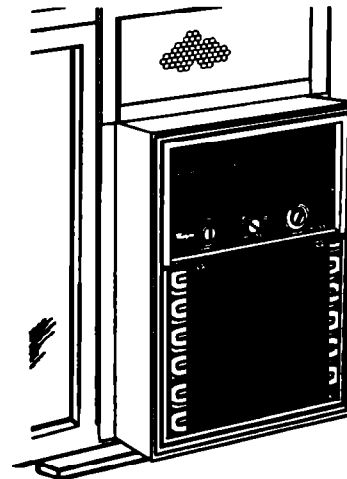

INSTALLING YOUR AIR CONDITIONER

13. Drill two $\frac{3}{4}$ -inch diameter pilot holes in the top window jamb in line with the partially plugged holes in the panel frame. Secure the panel frame to the window jamb with two #8-32 x $\frac{3}{4}$ -inch self-threading screws. If additional holding is necessary, two screws may be used on the sides of the panel frame as well.
14. Drill two screw-clearance holes in the cabinet side channels (near bottom) and two $\frac{3}{4}$ -inch diameter pilot holes in the side window jambs. Secure the cabinet side channels to the window jambs with two #8-32 x $\frac{3}{4}$ -inch self-threading screws. When doing this, be careful not to twist the side channel seals with the screws.
NOTE: The insertion of these screws will prevent the air conditioner from being pushed into the room.
15. Replace the air conditioner front panel frame. Make sure to replace the 2 screws that hold the panel in place. Do not push or pull on the front panel louvers.
16. Replace the air intake panel and air filter. Snap air filter into back of air intake panel before snapping air intake panel into place.

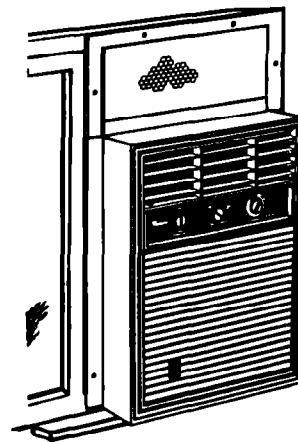
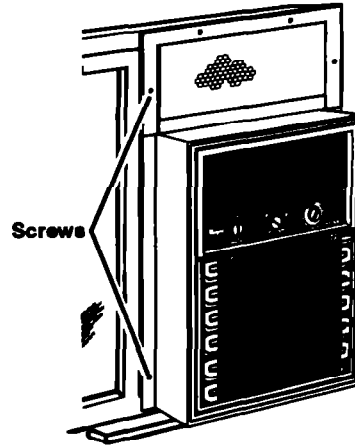

Operating Your Air Conditioner

In This Section		Page	Page
Starting your air conditioner	17	Cooling at low outside temperatures	18
Using the exhaust vent control	18	Adjusting the air direction louvers	19

In order to obtain the best possible results from your air conditioner, it is important that you operate it properly. This section will tell you how to do just that.

Starting your air conditioner

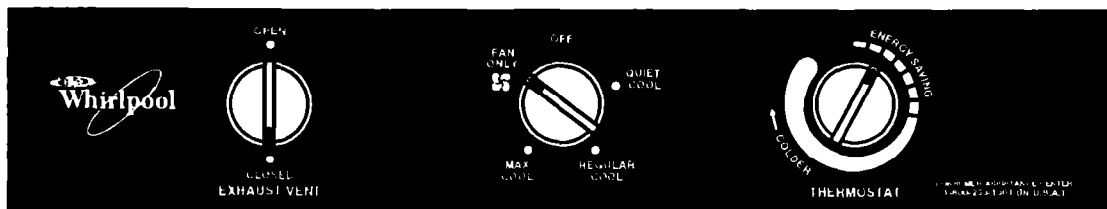

1. Set Exhaust Control to CLOSED for maximum cooling performance.
2. Set Fan Control to the desired setting.
QUIET COOLfor sleeping comfort
REGULAR COOLfor normal cooling
MAX COOLfor maximum cooling
FAN ONLYfor circulating room air when no cooling is desired
3. Turn the Thermostat Control to the desired setting. You can adjust the air conditioner's cooling performance by turning the Thermostat Control clockwise for more cooling or counterclockwise for less cooling. You will need to experiment to find the setting which suits you best.

NOTE: If you turn your air conditioner off or if the compressor turns off when lowering the Thermostat Control, wait at least 3 minutes before turning it back on. Doing this keeps the air conditioner from blowing a fuse or tripping a circuit breaker.

⚠ WARNING

Electrical Shock Hazard

- Plug unit only into grounded electrical outlet.
- Do not use an extension cord.
- Do not operate unit with front panel removed.

Failure to follow the above precautions could result in electrical shock or personal injury.

OPERATING YOUR AIR CONDITIONER

Using the exhaust vent control

The Exhaust Vent Control draws stale or smoky air from the room or circulates existing room air.

To exhaust room air:

1. Set Exhaust Control to OPEN.
2. Set Fan Control to desired setting. If no cooling is desired, set Fan Control to FAN ONLY.
3. Set Thermostat Control to desired setting.

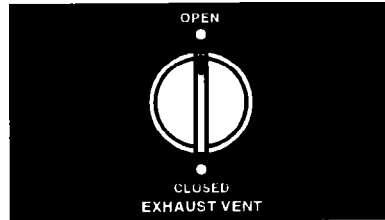

To circulate room air:

1. Set Exhaust Control to CLOSED.
2. Set Fan Control to desired setting. If no cooling is desired, set Fan Control to FAN ONLY.
3. Set Thermostat Control to desired setting.

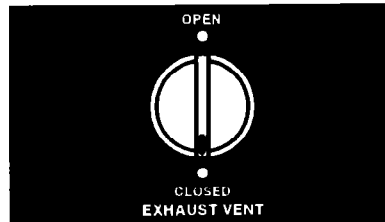

NOTE: For maximum performance, the Exhaust Vent Control must be in the CLOSED position when cooling or room air circulation is desired.

Cooling at low outside temperatures

When the outside temperature drops below 70°F and the air conditioner is cooling, frost may form on the coils behind the air intake panel. This will block the airflow into the room.

To defrost the coils:

- Set the Fan Control to the FAN ONLY setting and allow unit to run until frost is gone.

To prevent frost build-up:

1. Set the Fan Control to desired COOL setting.
2. Set Thermostat Control to the middle setting.
3. Make sure all louvers are open.

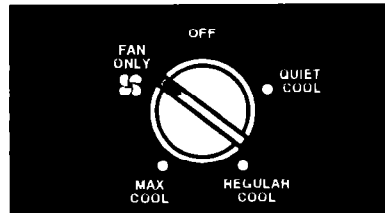

OPERATING YOUR AIR CONDITIONER

Adjusting the air direction louvers

The air direction louvers control the airflow direction. Your air conditioner can direct the airflow in 4 directions – up, down, left or right.

To direct airflow up or down:

- Tilt the louvers up or down with the tabs located at the outside edges of the louvers.

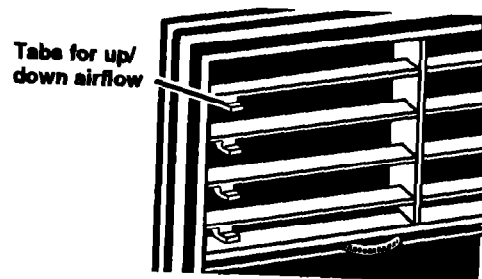

To direct airflow left or right:

- Turn thumb wheel to the left or right for desired airflow.

NOTE: The tabs and thumb wheels can be adjusted separately for a variety of airflow combinations.

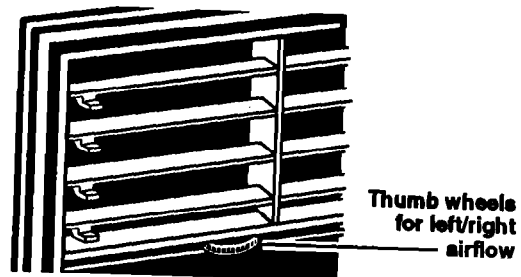

Caring For Your Air Conditioner

In This Section		Page	Page
Cleaning the air intake panel	20	Understanding normal operating sounds ...	23
Cleaning the air filter	21	Saving energy	23
Performing annual maintenance	21		

Proper maintenance of your air conditioner will help ensure longer life and lower operating costs. This section will tell you how to clean your air conditioner and perform annual maintenance. You can always call your authorized Whirlpool® servicing dealer for an annual check-up.

⚠ WARNING

Electrical Shock and Fire Hazard

- Unplug power cord from receptacle before cleaning unit. Failure to do so could result in electrical shock or personal injury.
- Do not use flammable fluids, solvents, abrasive cleaners or strong detergents. Fire or product damage could result.

Cleaning the air intake panel

1. Unplug the power cord.
2. Remove the air intake panel from unit for cleaning. Press down at top of panel to release it from the front panel frame.
3. Tilt top of panel toward you.
4. Lift panel up and away from the bottom spring clips.
5. Remove the air filter from the back side of the air intake panel and clean it separately. (See "Cleaning the air filter" on page 21.)
6. Clean air intake panel with warm water, mild soap or detergent and a soft cloth. Rinse and dry thoroughly.
7. Wipe control panel clean with a soft, dry cloth.
8. Replace air filter.
9. Replace the air intake panel. Locate bottom of panel on the spring clips. Press down on top edge of panel and push it toward the unit to secure the upper tabs.
10. Plug in the power cord.

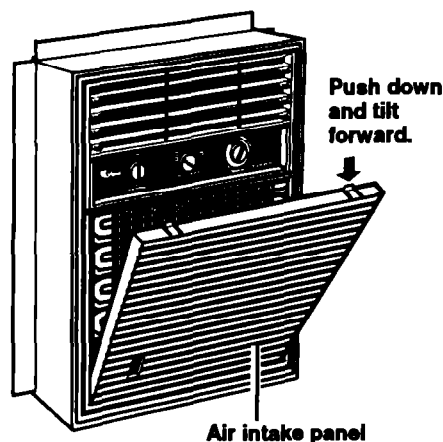

Cleaning the air filter

The filter is cleanable. A clean filter helps remove dust, lint and other particles from the air. Check every two weeks to see if filter needs cleaning.

1. Press down the top of the air intake panel to release it from the front panel frame. (See "Cleaning the air intake panel" on page 20.)
2. Tilt top of air intake panel toward you and lift it up off the bottom spring clips.
3. Turn air intake panel over and remove air filter.
4. Clean filter using a vacuum cleaner.
OR
If very dirty, wash filter with warm water and a mild detergent. Air dry filter thoroughly before replacing in air intake panel.
5. Replace air filter and air intake panel.

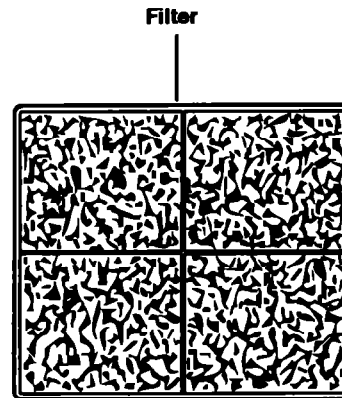

Performing annual maintenance

Your air conditioner needs annual maintenance to ensure steady, top performance throughout the year.

Call the service company recommended by your dealer to:

- Inspect and clean the coils and condensate water passages.
- Check fan and fan motor.

The compressor and fan motor are sealed and need no oiling. Expense of annual inspection is the customer's responsibility.

OR

If you are familiar with electrical appliances, you can do the cleaning and maintenance yourself. If you choose to do so, follow these steps.

⚠ WARNING

Electrical Shock, Product Damage and Personal Injury Hazard

- Unplug power cord from receptacle before performing any maintenance. Be sure no liquid gets into the motor, electrical control box or compressor electrical terminals.
- Do not lift, push or pull any white beaded foam (expanded polystyrene) parts.
- Because your air conditioner weighs from 88 to 105 pounds, it is recommended that you have someone help you when you remove and re-install your unit and that you both use proper lifting techniques.
- Handle the air conditioner with care. Watch out for the sharp, metal fins on the front and rear coils.
- Do not use the collected water for drinking purposes. It is not sanitary.

Failure to follow the above precautions could result in electrical shock, product damage or personal injury.

continued on next page

CARING FOR YOUR AIR CONDITIONER

1. Unplug the power cord.
2. Remove the air intake panel. (See "Cleaning the air intake panel" on page 20.)
3. Remove 2 phillips-head screws holding front panel frame in place. Then remove front panel frame the same way you removed the air intake panel.
4. Remove the air conditioner from the window.
5. Remove the 6 slotted hex-head screws along the base of the cabinet (3 per side—as shown).
6. Remove the 1 slotted hex-head screw from the left side of the cabinet (as shown).
7. Holding the cabinet on both sides, carefully lift cabinet off base.
8. Wrap the motor, electrical control box and compressor terminal box in plastic film to make sure no water or other liquids get inside. Water or other liquids could damage the insulation and cause serious mechanical problems.
9. Clean and hose out the base, coils and condensate pans. Clean air conditioner at least once a year or more often if the condenser coils and pans collect dirt, sand, leaves, insects or algae. Also, clean the air conditioner if you detect an odor coming from it.
10. Remove plastic film from the motor and electrical parts.
11. Replace cabinet over base and tighten all screws.
12. Reinstall air conditioner in the window.
13. Replace the air intake panel and front panel frame.
14. Plug in the power cord.

NOTE: It is a good idea to wait 24 hours before starting the air conditioner again. Doing so allows time for all areas to dry thoroughly.

The water from rainfall or from normal operation does not harm the motor or electrical parts.

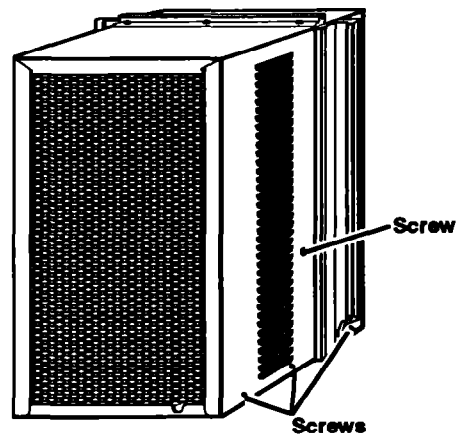

Understanding normal operating sounds

When your air conditioner is **operating normally**, you will hear sounds such as:

- Droplets of water hitting the condenser, causing a “pinging” or “clicking” sound. Water droplets help to cool the condenser.
- Air movement from the fan, especially on high fan speed settings.
- Clicks from the thermostat cycle.

Sounds also may be caused by house construction—such as vibration of the unit due to wall construction or unsteady window mounting area.

Saving energy

You can help save energy by following the tips below.

- Improve your home’s insulation. Seal all doors and windows. Close the fireplace flue.
- Close all blinds and drapes on sunny sides of the house. Add window awnings.
- Keep the air filter clean.
- Do not block the airflow with drapes or furniture.
- Ventilate the attic. High temperatures in the attic add to the air conditioner’s cooling load.
- Try not to use heat-producing appliances during the hottest part of the day.
- Turn off lights and appliances when they are not needed.
- Keep heat registers and cool-air returns closed.
- Use exhaust venting fans when cooking, doing laundry or bathing.

If You Need Assistance Or Service

This section is designed to help you save the cost of a service call. Part 1 outlines possible problems, their causes, and actions you can take to solve each problem. Parts 2 and 3 tell you what to do if you still need assistance or service. When calling our Consumer Assistance Center for help or calling for service, please provide a detailed description of the problem, your appliance's complete model and serial numbers and the purchase or installation date. (See page 2.) This information will help us respond properly to your request.

1. Before calling for assistance ...

Performance problems often result from little things you can find and fix without tools of any kind. Please check the chart below for problems you can fix. It could save you the cost of a service call.

PROBLEM	POSSIBLE CAUSE	SOLUTION
Air conditioner will not run	Unit is not plugged into a live circuit with proper voltage. The Fan Control is set to OFF. The Thermostat Control is not set correctly. A household fuse has blown or a circuit breaker has tripped. The local power has failed.	Plug unit into a live circuit with proper voltage. Set the Fan Control to a setting other than OFF. Set the Thermostat Control to a setting cooler than the room temperature. Replace fuse or reset circuit breaker. Wait for power to be restored.
Unit blows household fuses or trips circuit breaker	A time-delay fuse is not being used. An extension cord is being used. The unit was just turned off and on again.	Replace fuse with a time-delay fuse of the correct capacity. Do not use an extension cord to run your air conditioner. Wait three minutes after turning unit off before trying to restart it.
Unit turns on and off, or does not cool/heat room	The filter is dirty. The coils (evaporator [inside] and condenser [outside]) are dirty. There is excessive moisture or heat in the room. The fan speed setting is too low. The Thermostat Control is not set correctly.	Clean the filter. (See page 21.) Clean the coils. (See pages 21-22.) It will take longer for the unit to cool or heat a room when there is excess moisture or heat (open cooking vessel, shower, etc.). Set Fan Control to a higher setting. Set the Thermostat Control to a cooler setting.
Ice forms on coils behind air intake panel	Outdoor temperature is below 70°F.	Defrost coils. (See "Cooling at low outside temperatures" on page 18.)

IF YOU NEED ASSISTANCE OR SERVICE

2. If you need assistance ...

Call Whirlpool Consumer Assistance Center telephone number. Dial free from anywhere in the U.S.A.:

1-800-253-1301

and talk with one of our trained consultants. The consultant can instruct you in how to obtain satisfactory operation from your appliance or, if service is necessary, recommend a qualified service company in your area.

If you prefer, write to:

Mr. William Clark
Consumer Assistance Representative
Whirlpool Corporation
2000 M-63
Benton Harbor, MI 49022

Please include a daytime phone number in your correspondence.

3. If you need service ...

Whirlpool has a nationwide network of authorized Whirlpool® service companies. Whirlpool service technicians are trained to fulfill the product warranty and provide after-warranty service, anywhere in the United States. To locate the authorized Whirlpool service company in your area, call our Consumer Assistance Center telephone number (see Step 2) or look in your telephone directory Yellow Pages under:

**• APPLIANCE-HOUSEHOLD-
MAJOR, SERVICE & REPAIR**

- See: Whirlpool Appliances or
Authorized Whirlpool Service
(Example: XYZ Service Co.)

**• WASHING MACHINES &
DRYERS, SERVICE & REPAIR**

- See: Whirlpool Appliances or
Authorized Whirlpool Service
(Example: XYZ Service Co.)

4. If you need FSP® replacement parts ...

FSP is a registered trademark of Whirlpool Corporation for quality parts. Look for this symbol of quality whenever you need a replacement part for your Whirlpool appliance. FSP replacement parts will fit right and work right, because they are made to the same exacting specifications used to build every new Whirlpool appliance.

To locate FSP replacement parts in your area, refer to Step 3 above or call the Whirlpool Consumer Assistance Center number in Step 2.

5. If you are not satisfied with how the problem was solved ...

- Contact the Major Appliance Consumer Action Panel (MACAP). MACAP is a group of independent consumer experts that voices consumer views at the highest levels of the major appliance industry.
- Contact MACAP only when the dealer, authorized servicer and Whirlpool have failed to resolve your problem.
Major Appliance Consumer Action Panel
20 North Wacker Drive
Chicago, IL 60606
- MACAP will in turn inform us of your action.

WHIRLPOOL®

Room Air Conditioner Warranty

LENGTH OF WARRANTY	WHIRLPOOL WILL PAY FOR
FULL ONE-YEAR WARRANTY From Date of Purchase	FSP® replacement parts and repair labor to correct defects in materials or workmanship.
FULL FIVE-YEAR WARRANTY From Date of Purchase	FSP replacement parts and repair labor to correct defects in materials or workmanship in the sealed refrigeration system. These parts are: 1. Compressor 4. Drier-strainer 2. Evaporator 5. Connecting tubing 3. Condenser
WHIRLPOOL WILL NOT PAY FOR	
<p>A. Service calls to:</p> <ol style="list-style-type: none"> 1. Correct the installation of your air conditioner. 2. Instruct you in how to use your air conditioner. 3. Replace house fuses or correct house wiring. 4. Clean or replace the air filter. <p>B. Pickup and delivery. Your air conditioner is designed to be repaired in the home.</p> <p>C. Damage to your air conditioner caused by accident, misuse, fire, flood, acts of God or use of products not approved by Whirlpool.</p> <p>D. The removal and reinstallation of your air conditioner if it is installed in an overhead or other inaccessible location or not installed in accordance with published installation instructions.</p> <p>E. Repairs to parts or systems caused by unauthorized modifications made to the appliance.</p>	

5-93

Service under the full warranties must be provided by an authorized Whirlpool service company.

WHIRLPOOL CORPORATION SHALL NOT BE LIABLE FOR INCIDENTAL OR CONSEQUENTIAL DAMAGES. Some states do not allow the exclusion or limitation of incidental or consequential damages, so this limitation or exclusion may not apply to you. This warranty gives you specific legal rights, and you may also have other rights which vary from state to state.

Outside the United States, a different warranty may apply. For details, please contact your authorized Whirlpool distributor or military exchange.

If you need service, first see the "Assistance or Service" section of this book. After checking "Assistance or Service," additional help can be found by calling our Consumer Assistance Center telephone number, 1-800-253-1301, from anywhere in the U.S.A.